

Article number: 0118037

Description: Retaining ring H 20

Measures

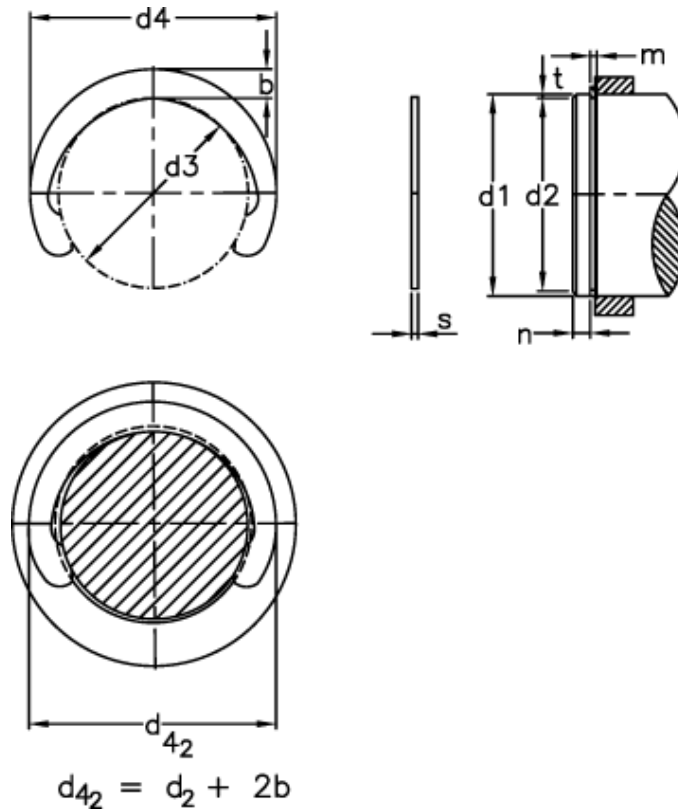

b	= 2.55	FRg kN	= 3.0	t	= 0.95
d1	= 20	FR kN	= 9.40	tol	= -0.21
d2	= 18.1	g	= 1.20	tol	= 0.18
d3	= 17.55	Gripper	= GRH 20	tol	= -0.06
d4	= 22.65	m min	= 1.30	Weight kg/1000	= 0.87
d4 2	= 23.2	n abl x 1000	= 20		
Description	= H 20,0	Nominal drive	= 2.9		
FN kN	= 4.70	s	= 1.20		